



STR S



> 3 LUMINOUS SOURCES <
> EXCELLENT OPTICAL PERFORMANCE <



STR STEADY

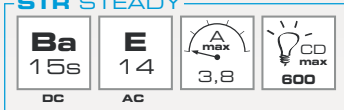

STR FLASHING

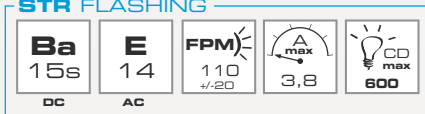

STR LED

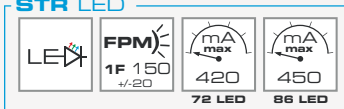

STR X

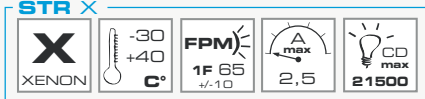

ALSO AVAILABLE



STR P

STR

Large size beacon engineered for industrial applications.

With the protection grid the product is suitable for heavy-duty applications.

Available with 3 light technologies, STR delivers a complete and versatile range of devices.

KEY CHARACTERISTICS

LIGHT EFFECTS

- STR STEADY: STEADY LIGHT
- STR FLASHING: FLASHING LIGHT
- STR LED: STEADY/FLASHING LIGHT
- STR X: XENON FLASHING LIGHT

VOLTAGES

- STR STEADY: 12V ACDC, 24V ACDC, 48V DC, 48V AC, 110V ACDC and 240V ACDC +/-10%
- STR FLASHING: 12V DC, 12V AC, 24V DC, 24V AC, 48V DC, 48V AC, 110V AC, 240V AC +/-10%
- STR LED: 24V ACDC, 48V ACDC, 110V AC and 240V AC +/-10%
- STR X: 12/24V ACDC, 110V AC and 240V AC +/-10%

PROTECTION GRADE

IP65

OPERATING TEMPERATURE

-30/+50 °C | X: -30/+40 °C

MECHANICAL FEATURES

Self-extinguishing high impact resistance PC dome
Aluminium base available for flat surface mounting through screws not included (STR S) or for pole mounted installations (Ø 48,5) with 2 retaining dowels (STR P)

OPTICAL FEATURES

STR STEADY and FLASHING: BA 15s 45W bulb (for 12V ACDC, 24V ACDC, 48V DC versions) or E14S 40W bulb (for 48V AC, 110V AC and 240V AC versions)

STR LED: two versions available: 72 x 5mm colored LEDs or 86 x 5mm colored LEDs (vertical light)

STR X: 15J Xenon discharge tube provides a strong single flash (1F). 6J and 20J versions available on request

CERTIFICATIONS





GRID

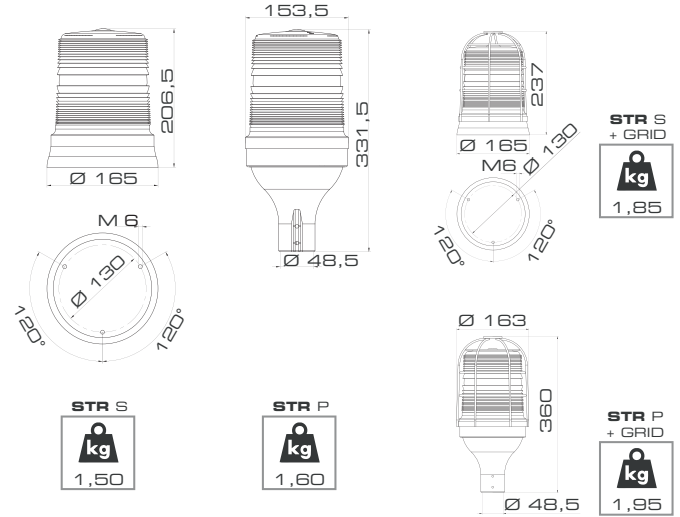

STR STEADY* - Steady light with incandescent bulb

S BASE	BK	BK	BK	BK	BK	BK
12V ACDC	90663	81600	90664	90665	90666	90667
24V ACDC	81628	81601	81602	81625	81615	81626
48V DC	90668	90669	90670	90671	90672	90673
48V AC	90674	81606	81614	90675	90676	90677
110V ACDC	81639	81607	81633	81637	81638	81646
240V ACDC	81599	81613	81616	81664	81596	81598
P BASE						
12V ACDC	90630	90631	81611	90632	90633	90634
24V ACDC	90635	81634	81603	90636	90637	81635
48V DC	90638	90639	81618	90640	90641	90642
48V AC	90643	90644	90645	90646	90647	90648
110V ACDC	81623	90865	90866	90867	90868	90869
240V ACDC	81647	81597	81629	81612	81620	81624

*Supplied with bulb







STR FLASHING* - Flashing light with incandescent bulb

S BASE	BK	BK	BK	BK	BK	BK
12V DC	87201	87200	87203	87204	87235	87202
12V AC	87206	87205	87208	87209	86978	87207
24V DC	87211	87210	87213	87214	87236	87212
24V AC	87216	87215	87218	87241	87219	87217
48V DC	86977	87239	87240	86976	87242	86975
48V AC	86974	87243	87244	86896	86895	86894
110V AC	87221	87220	87223	87224	87237	87222
240V AC	87231	87230	87233	87234	87245	87232
P BASE						
12V DC	87271	87270	87273	87274	87326	87272
12V AC	87276	87275	87278	87279	87407	87277
24V DC	87281	87280	87283	87284	87408	87282
24V AC	87286	87285	87288	87289	87412	87287
48V DC	90870	90871	87415	90872	87347	90873
48V AC	90874	87327	87325	90875	90876	90877
110V AC	87291	87336	87293	87294	87409	87292
240V AC	87301	87300	87303	87304	87290	87302







*Supplied with bulb

STR LED - LED steady/flashing light

72 LED

						
S BASE	BK	BK	BK	BK	BK	BK
24V ACDC	65791	65792	65793	65794	65795	65796
48V ACDC	65801	65802	65803	65804	65805	65806
110V AC	65811	65812	65813	65814	65815	65816
240V AC	65821	65822	65823	65824	65825	65826
P BASE						
24V ACDC	65831	65832	65833	65834	65835	65836
48V ACDC	65841	65842	65843	65844	65845	65846
110V AC	65851	65852	65853	65854	65855	65856
240V AC	65861	65862	65863	65864	65865	65866
86 LED - Vertical light						
S BASE						
24V ACDC	65871	65872	65873	65874	65875	65876
48V ACDC	65881	65882	65883	65884	65885	65886
110V AC	65891	65892	65893	65894	65895	65896
240V AC	65901	65902	65903	65904	65905	65906
P BASE						
24V ACDC	65911	65912	65913	65914	65915	65916
48V ACDC	65921	65922	65923	65924	65925	65926
110V AC	65931	65932	65933	65934	65935	65936
240V AC	65941	65942	65943	65944	65945	65946

STR X* - Flashing light with Xenon discharge tube 15J 1F

						
S BASE	BK	BK	BK	BK	BK	BK
12/24V ACDC	22190	22191	22192	22194	22193	22195
110V AC	87648	87656	87730	87649	87658	87749
240V AC	87758	87760	87759	87761	87762	87763
P BASE						
12/24V ACDC	90878	22281	22282	90879	22284	22285
110V AC	87717	87757	90880	90881	87765	90882
240V AC	87766	87767	87768	87769	87770	87771

*Supplied with bulb

STR SPARE PARTS

Dome  71386  71385  71388  71389  71383  71387

P BASE for STR **BK** 83055

ACCESSORIES

GRID for STR **STL** 71693